

Catalogue number: **MC-□□ □□**



Magnetic Contactors: 3 Pole 6A ~ 2100A 50/60Hz



Magnetic Contactors 3 Pole 6A~ 2100A 50/60Hz

- AC control coil on selection
- 3-pole (NO) main contact
- Finger proof design
- DIN rail or screw mountable
- IEC/EN 60947-1, 60947-4-1

Generic photo only (actual product may change depending on configuration)

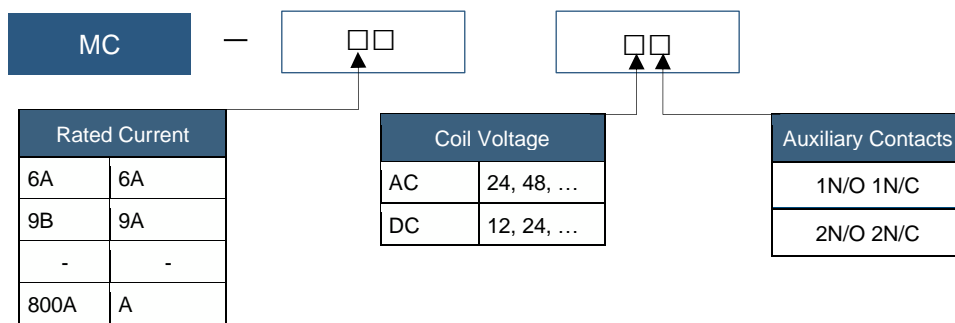

Units	Coil Voltages	
	AC Units	DC Units
Below MC-185A	24VAC, 32VDC, 48VAC, 110VAC, 240VAC, 415VAC	12VDC, 24VDC, 48VDC
Above MC-185A	24VAC, 48VAC, 110-220VAC, 380-450VAC	24VDC, 48VDC, 110-220VDC

Circuit Diagram & Markings

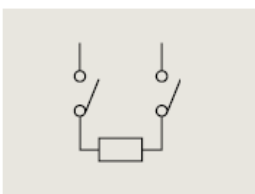

2pole for DC contact

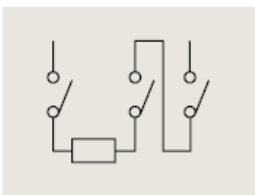

3pole for DC contact

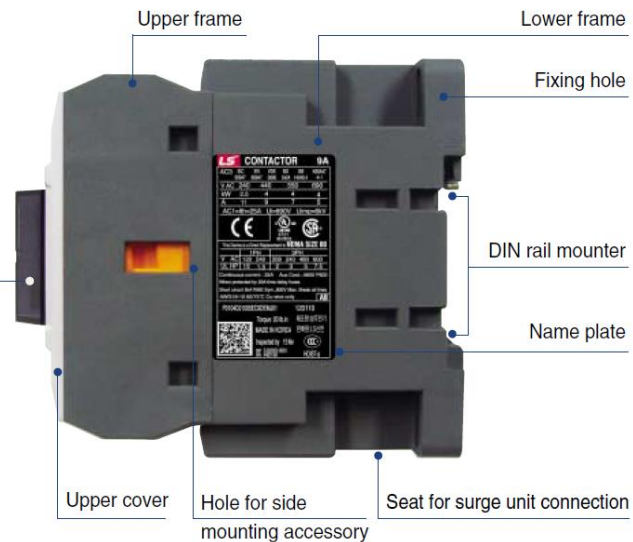
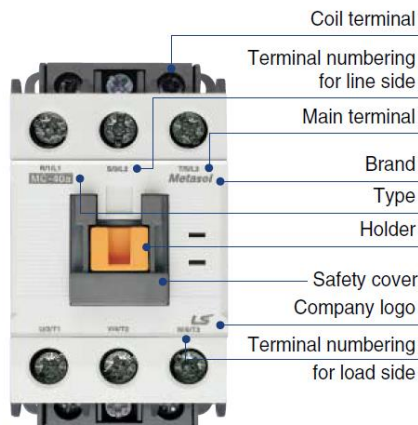

MC Type		MC-6A	MC-9A	MC-12A	MC-18A	MC-9B	MC-12B	MC-18B	MC-22B	MC-32A	MC-40A	MC-50A	MC-65A	MC-75A	MC-85A	MC-100A																																																																																																																																																																																																																																																																																																																																																																																																																																																																																																																																																																																																																																																											
		Terminal Type	Screw Clamps	Y	Y	Y	Y	Y	Y	Y	Y	Y	Y	Y	Y	Y	Y	Y		Lug Clamps	N	N	N	N	N	N	N	N	N	N	Y	Y	Y	Y	Y	Number of poles		3pole										3pole						Rated operational voltage, Ue		690V										1000V						Rated insulation voltage, Ui		690V										1000V						Rated frequency		50/60Hz										50/60Hz						Rated impulse withstand voltage, Uimp		6kV										8kV						Maximum operating rate in AC3		1800 operations per hour										1200 operations per hour						Durability	Mechanical	15 mil. operations				16 mil. operations				12 mil. operations								Electrical	2.5 mil. operations				2.5 mil. operations				2 mil. operations								Current and Power	AC-1	Thermal Current A	25	25	25	32	27	27	32	45	55	60	100	115	125	135	160	AC-3	2000/240V	KW	2.2	2.5	3.5	4.5	2.5	3.5	4.5	5.5	7.5	11	15	18.5	22	25	30		A	9	11	13	18	28	27	32	45	32	40	55	65	75	85	105		380/440V	KW	3	4	5.5	7.5	4	5.5	7.5	11	15	18.5	22	30	37	45	55		A	7	9	12	18	9	12	18	22	32	40	50	65	75	85	105		500/550V	KW	3	4	7.5	7.5	4	7.5	7.5	15	18.5	22	30	33	37	45	55		A	6	7	12	13	7	12	13	20	28	32	43	60	64	75	85		690V	KW	3	4	7.5	7.5	4	7.5	7.5	15	18.5	22	30	33	37	45	55		A	4	5	9	9	6	9	9	18	20	23	28	35	42	45	65		1000V	KW	-	-	-	-	-	-	-	-	22	22	30	30	37	37	37		A	-	-	-	-	-	-	-	-	17	17	23	23	28	28	28	Rated Short-time withstand current (IEC 60947)		1s	A	210	250	280	300	250	280	300	400	600	700	1000	1050	1100	1200	1320		10s	A	105	110	120	130	110	120	154	186	260	300	550	700	750	800	900		30s	A	70	70	80	85	70	80	100	130	160	160	330	380	400	450	500		1min	A	61	61	61	70	61	61	84	90	100	100	250	270	300	350	400		3min	A	40	45	47	50	45	50	60	60	70	70	150	200	220	270	270		10min	A	30	30	30	40	30	30	40	50	55	55	90	120	140	170	180		≥15min	A	2	26	28	40	26	28	40	45	50	50	87	100	114	150	160	UL rating(50/60Hz)	Continuous current	A	25	25	25	32	27	27	32	45	55	60	100	115	125	135	160	Single Phase	110-120V HP		0.5	0.5	0.75	1	0.5	0.75	1	2	2	2	3	5	5	7.5	10	220-240V HP		1.5	1.5	2	3	1.5	2	3	3	5	5	10	15	15	15	20	Three Phase	200-208V HP		2	2	3	7.5	2	3	7.5	7.5	7.5	15	20	25	25	30	30	220-240V HP		3	3	5	7.5	3	5	7.5	10	10	15	25	30	30	40	40	440-480V HP		5	5	7.5	10	5	7.5	10	15	20	30	40	50	50	60	75	550-600V HP		7	7.5	10	15	7.5	10	15	20	25	30	50	60	60	75	75	Auxilliary	Side Mount		UA-1				UA-1				UA-1		UA-1		UA-1		Front Mount		UA-2,UA-4				UA-2, UA-4				UA-2, UA-4		UA-2, UA-5	
	Lug Clamps	N	N	N	N	N	N	N	N	N	N	Y	Y	Y	Y	Y	Number of poles		3pole										3pole						Rated operational voltage, Ue		690V										1000V						Rated insulation voltage, Ui		690V										1000V						Rated frequency		50/60Hz										50/60Hz						Rated impulse withstand voltage, Uimp		6kV										8kV						Maximum operating rate in AC3		1800 operations per hour										1200 operations per hour						Durability	Mechanical	15 mil. operations				16 mil. operations				12 mil. operations								Electrical		2.5 mil. operations				2.5 mil. operations				2 mil. operations								Current and Power	AC-1	Thermal Current A	25	25	25	32	27	27	32	45	55	60	100	115	125	135	160		AC-3	2000/240V	KW	2.2	2.5	3.5	4.5	2.5	3.5	4.5	5.5	7.5	11	15	18.5	22	25		30		A	9	11	13	18	28	27	32	45	32	40	55	65	75	85	105		380/440V	KW	3	4	5.5	7.5	4	5.5	7.5	11	15	18.5	22	30	37		45	55		A	7	9	12	18	9	12	18	22	32	40	50	65	75	85	105		500/550V	KW	3	4	7.5	7.5	4	7.5	7.5	15	18.5	22	30	33		37	45	55		A	6	7	12	13	7	12	13	20	28	32	43	60	64	75	85		690V	KW	3	4	7.5	7.5	4	7.5	7.5	15	18.5	22	30		33	37	45	55		A	4	5	9	9	6	9	9	18	20	23	28	35	42	45	65		1000V	KW	-	-	-	-	-	-	-	-	22	22		30	30	37	37	37		A	-	-	-	-	-	-	-	-	17	17	23	23	28	28	28	Rated Short-time withstand current (IEC 60947)		1s	A	210	250	280	300	250	280	300	400		600	700	1000	1050	1100	1200	1320		10s	A	105	110	120	130	110	120	154	186	260	300	550	700	750	800	900		30s	A	70	70	80	85	70	80	100	130	160	160	330	380	400	450	500		1min	A	61	61	61	70	61	61	84	90	100	100	250	270	300	350	400		3min	A	40	45	47	50	45	50	60	60	70	70	150	200	220	270	270		10min	A	30	30	30	40	30	30	40	50	55	55	90	120	140	170	180		≥15min	A	2	26	28	40	26	28	40	45	50	50	87	100	114	150	160	UL rating(50/60Hz)	Continuous current	A	25	25	25	32	27	27	32	45	55	60	100	115	125	135	160	Single Phase	110-120V HP		0.5	0.5	0.75	1	0.5	0.75	1	2		2	2	3	5	5	7.5	10	220-240V HP		1.5	1.5	2	3	1.5	2	3	3	5	5	10	15	15	15	20	Three Phase	200-208V HP		2	2	3	7.5	2	3	7.5		7.5	7.5	15	20	25	25	30	30	220-240V HP		3	3	5	7.5	3	5	7.5	10	10	15	25	30	30	40	40	440-480V HP		5	5	7.5	10	5	7.5	10	15	20	30	40	50	50	60	75	550-600V HP		7	7.5	10	15	7.5	10	15	20	25	30	50	60	60	75	75	Auxilliary	Side Mount		UA-1				UA-1				UA-1		UA-1		UA-1		Front Mount		UA-2,UA-4				UA-2, UA-4				UA-2, UA-4		UA-2, UA-5		UA-2, UA-6								
Number of poles		3pole										3pole																																																																																																																																																																																																																																																																																																																																																																																																																																																																																																																																																																																																																																																															
Rated operational voltage, Ue		690V										1000V																																																																																																																																																																																																																																																																																																																																																																																																																																																																																																																																																																																																																																																															
Rated insulation voltage, Ui		690V										1000V																																																																																																																																																																																																																																																																																																																																																																																																																																																																																																																																																																																																																																																															
Rated frequency		50/60Hz										50/60Hz																																																																																																																																																																																																																																																																																																																																																																																																																																																																																																																																																																																																																																																															
Rated impulse withstand voltage, Uimp		6kV										8kV																																																																																																																																																																																																																																																																																																																																																																																																																																																																																																																																																																																																																																																															
Maximum operating rate in AC3		1800 operations per hour										1200 operations per hour																																																																																																																																																																																																																																																																																																																																																																																																																																																																																																																																																																																																																																																															
Durability	Mechanical	15 mil. operations				16 mil. operations				12 mil. operations																																																																																																																																																																																																																																																																																																																																																																																																																																																																																																																																																																																																																																																																	
	Electrical	2.5 mil. operations				2.5 mil. operations				2 mil. operations																																																																																																																																																																																																																																																																																																																																																																																																																																																																																																																																																																																																																																																																	
Current and Power	AC-1	Thermal Current A	25	25	25	32	27	27	32	45	55	60	100	115	125	135	160																																																																																																																																																																																																																																																																																																																																																																																																																																																																																																																																																																																																																																																										
	AC-3	2000/240V	KW	2.2	2.5	3.5	4.5	2.5	3.5	4.5	5.5	7.5	11	15	18.5	22	25	30																																																																																																																																																																																																																																																																																																																																																																																																																																																																																																																																																																																																																																																									
			A	9	11	13	18	28	27	32	45	32	40	55	65	75	85	105																																																																																																																																																																																																																																																																																																																																																																																																																																																																																																																																																																																																																																																									
		380/440V	KW	3	4	5.5	7.5	4	5.5	7.5	11	15	18.5	22	30	37	45	55																																																																																																																																																																																																																																																																																																																																																																																																																																																																																																																																																																																																																																																									
			A	7	9	12	18	9	12	18	22	32	40	50	65	75	85	105																																																																																																																																																																																																																																																																																																																																																																																																																																																																																																																																																																																																																																																									
		500/550V	KW	3	4	7.5	7.5	4	7.5	7.5	15	18.5	22	30	33	37	45	55																																																																																																																																																																																																																																																																																																																																																																																																																																																																																																																																																																																																																																																									
			A	6	7	12	13	7	12	13	20	28	32	43	60	64	75	85																																																																																																																																																																																																																																																																																																																																																																																																																																																																																																																																																																																																																																																									
		690V	KW	3	4	7.5	7.5	4	7.5	7.5	15	18.5	22	30	33	37	45	55																																																																																																																																																																																																																																																																																																																																																																																																																																																																																																																																																																																																																																																									
			A	4	5	9	9	6	9	9	18	20	23	28	35	42	45	65																																																																																																																																																																																																																																																																																																																																																																																																																																																																																																																																																																																																																																																									
		1000V	KW	-	-	-	-	-	-	-	-	22	22	30	30	37	37	37																																																																																																																																																																																																																																																																																																																																																																																																																																																																																																																																																																																																																																																									
		A	-	-	-	-	-	-	-	-	17	17	23	23	28	28	28																																																																																																																																																																																																																																																																																																																																																																																																																																																																																																																																																																																																																																																										
Rated Short-time withstand current (IEC 60947)		1s	A	210	250	280	300	250	280	300	400	600	700	1000	1050	1100	1200	1320																																																																																																																																																																																																																																																																																																																																																																																																																																																																																																																																																																																																																																																									
		10s	A	105	110	120	130	110	120	154	186	260	300	550	700	750	800	900																																																																																																																																																																																																																																																																																																																																																																																																																																																																																																																																																																																																																																																									
		30s	A	70	70	80	85	70	80	100	130	160	160	330	380	400	450	500																																																																																																																																																																																																																																																																																																																																																																																																																																																																																																																																																																																																																																																									
		1min	A	61	61	61	70	61	61	84	90	100	100	250	270	300	350	400																																																																																																																																																																																																																																																																																																																																																																																																																																																																																																																																																																																																																																																									
		3min	A	40	45	47	50	45	50	60	60	70	70	150	200	220	270	270																																																																																																																																																																																																																																																																																																																																																																																																																																																																																																																																																																																																																																																									
		10min	A	30	30	30	40	30	30	40	50	55	55	90	120	140	170	180																																																																																																																																																																																																																																																																																																																																																																																																																																																																																																																																																																																																																																																									
		≥15min	A	2	26	28	40	26	28	40	45	50	50	87	100	114	150	160																																																																																																																																																																																																																																																																																																																																																																																																																																																																																																																																																																																																																																																									
UL rating(50/60Hz)	Continuous current	A	25	25	25	32	27	27	32	45	55	60	100	115	125	135	160																																																																																																																																																																																																																																																																																																																																																																																																																																																																																																																																																																																																																																																										
Single Phase	110-120V HP		0.5	0.5	0.75	1	0.5	0.75	1	2	2	2	3	5	5	7.5	10																																																																																																																																																																																																																																																																																																																																																																																																																																																																																																																																																																																																																																																										
	220-240V HP		1.5	1.5	2	3	1.5	2	3	3	5	5	10	15	15	15	20																																																																																																																																																																																																																																																																																																																																																																																																																																																																																																																																																																																																																																																										
Three Phase	200-208V HP		2	2	3	7.5	2	3	7.5	7.5	7.5	15	20	25	25	30	30																																																																																																																																																																																																																																																																																																																																																																																																																																																																																																																																																																																																																																																										
	220-240V HP		3	3	5	7.5	3	5	7.5	10	10	15	25	30	30	40	40																																																																																																																																																																																																																																																																																																																																																																																																																																																																																																																																																																																																																																																										
	440-480V HP		5	5	7.5	10	5	7.5	10	15	20	30	40	50	50	60	75																																																																																																																																																																																																																																																																																																																																																																																																																																																																																																																																																																																																																																																										
	550-600V HP		7	7.5	10	15	7.5	10	15	20	25	30	50	60	60	75	75																																																																																																																																																																																																																																																																																																																																																																																																																																																																																																																																																																																																																																																										
Auxilliary	Side Mount		UA-1				UA-1				UA-1		UA-1		UA-1																																																																																																																																																																																																																																																																																																																																																																																																																																																																																																																																																																																																																																																												
	Front Mount		UA-2,UA-4				UA-2, UA-4				UA-2, UA-4		UA-2, UA-5		UA-2, UA-6																																																																																																																																																																																																																																																																																																																																																																																																																																																																																																																																																																																																																																																												

MC Type			MC-130a	MC-150a	MC-185A	MC-225a	MC-265a	MC-330A	MC-400a	MC-500a	MC-630a	MC-800A		
			Y	Y	Y	Y	Y	Y	Y	Y	Y	Y	Y	
Terminal Type	Screw Clamps		Y	Y	Y	Y	Y	Y	Y	Y	Y	Y		
	Lug Clamps		Y	Y	Y	Y	N	N	N	N	N	N		
Number of poles			3pole						3pole					
Rated operational voltage, Ue			1000V						1000V					
Rated insulation voltage, Ui			1000V						1000V					
Rated frequency			50/60Hz						50/60Hz					
Rated impulse withstand voltage, Uimp			8kV						8kV					
Maximum operating rate in AC3			1200 operations per hour											
Durability	Mechanical		5 mil. operations						2.5 mil. Operations					
	Electrical		1 mil. operations						0.5 mil. operations					
Current and Power	AC-1	Thermal Current A	200	250	300	350	400	500	520	700	900	1050		
	AC-3	2000/240V	KW	37	45	55	75	80	90	125	147	190	220	
			A	130	150	185	225	265	330	400	500	630	800	
		380/440V	KW	60	75	90	132	147	160	200	265	330	440	
			A	130	150	185	225	265	330	400	500	630	800	
		500/550V	KW	60	70	110	132	147	160	225	265	330	500	
			A	90	100	180	200	225	250	350	400	500	720	
		690V	KW	55	55	110	140	160	200	250	300	400	500	
			A	60	60	120	150	185	220	300	380	420	630	
		1000V	KW	75	75	132	132	147	147	147	280	280	280	
		A	53	53	90	90	105	105	105	220	220	220		
Rated Short-time withstand current (IEC 60947)	1s	A	1350	1800	2000	2500	3500	4000	4600	6000	7000	7500		
	10s	A	950	1200	1500	1700	2400	3000	4400	5050	6400	7000		
	30s	A	700	800	1000	1200	1500	2500	2974	4400	4500	4900		
	1min	A	550	600	800	1000	1100	1700	1846	3400	3500	3800		
	3min	A	350	450	520	700	800	1000	1313	2000	2200	2500		
	10min	A	200	300	350	500	600	620	760	1400	1550	1550		
	≥15min	A	175	280	320	400	500	553	699	1100	1300	1300		
UL rating(50/60Hz)	Continuous current A		200	250	300	350	400	500	520	700	900	1050		
Single Phase	110-120V HP		10	15	15	15	-	-	-	-	-	-		
	220-240V HP		20	25	30	40	-	-	-	-	-	-		
Three Phase	200-208V HP		40	40	60	60	75	100	125	150	200	200		
	220-240V HP		40	50	60	75	100	100	150	200	250	2300		
	440-480V HP		75	100	125	150	200	200	300	400	500	600		
	550-600V HP		75	75	125	150	200	200	300	400	500	600		
Auxilliary	Side Mount		UA-1		AU-100, AU-100E (Max.4a4b)				AU-100, AU-100E (Max.4a4b)					
	Front Mount		UA-2, UA-4		-				-					

Catalogue number: **MC-□□ □□**



Magnetic Contactors: 3 Pole 6A ~ 2100A 50/60Hz

Environment	
Standards	IEC/EN 60947-1, IEC/EN 60947-4-1, UL508, K60947
Certifications	CE, UL
Rated insulation voltage (Ui)	1000V
Rated impulse withstands voltage (Uimp)	8kV
Degree of protection	IP20 (Conforming to IEC60529)
Ambient air temperature	Storage: -5 ~ 40°C Operation: 5°C ~ +55°C (AC Type) -5°C ~ +40°C (DC Type)
Operating altitude	3000m (8900ft)
Operating altitude	3000m (8900ft)
Shock resistance Opened:	8G
(1/2 sine wave =11ms) Closed:	10G
Vibration resistance (Conforming to IEC68-2-6) Opened:	2G
(5...300 Hz) Closed:	4G
Flame resistance	Conforming to UL 94: V0 Conforming to IEC 695-2-1: 960°C

### MC-6A~18A AC Dimensions

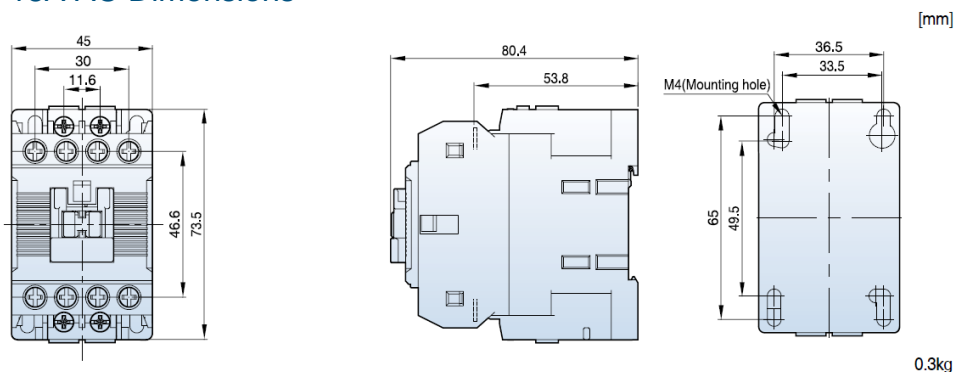

### MC-6A~18A DC Dimensions

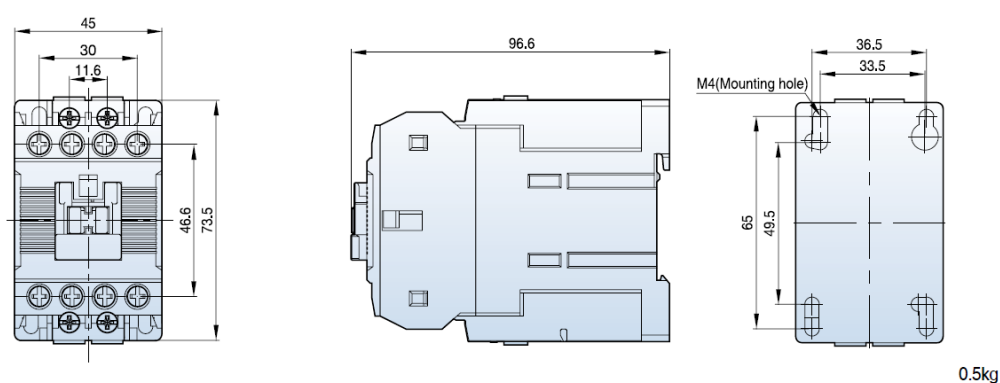

Catalogue number: **MC-□□ □□**



Magnetic Contactors: 3 Pole 6A ~ 2100A 50/60Hz

### MC-9B~22B AC Dimensions

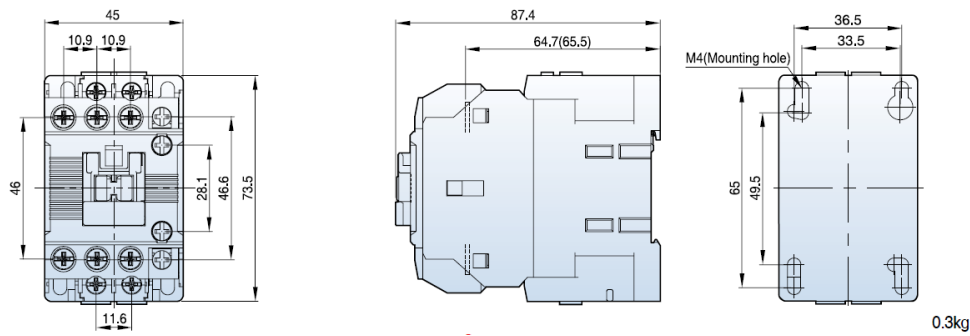

### MC-9B~22B DC Dimensions

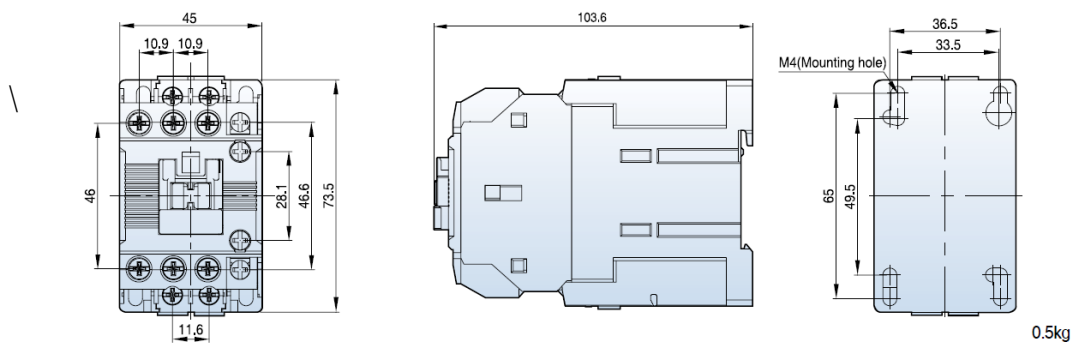

### MC-32A~40A AC Dimensions

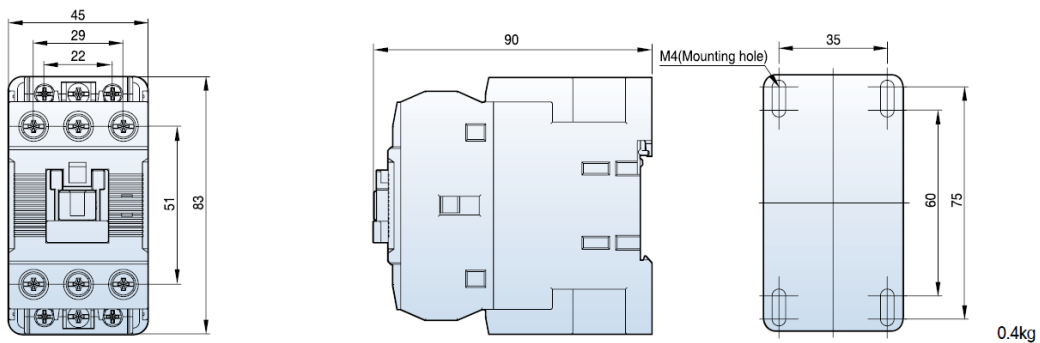

### MC-32A~40A DC Dimensions

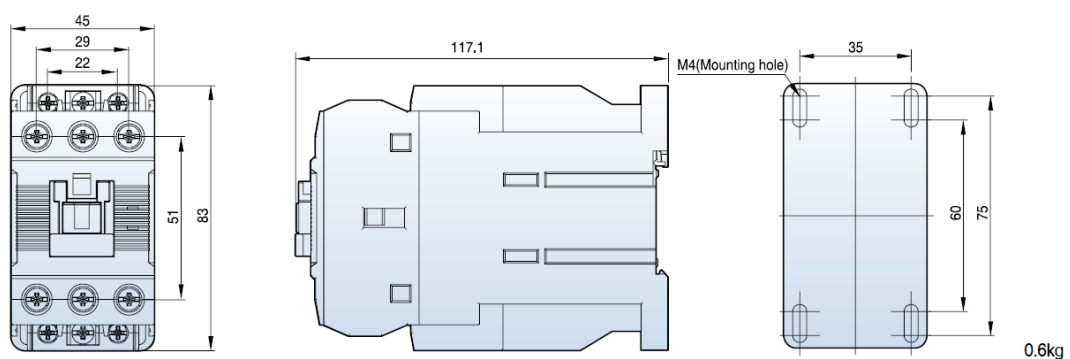

Catalogue number: **MC-□□ □□**



Magnetic Contactors: 3 Pole 6A ~ 2100A 50/60Hz

### MC-32A~40A AC 2NO2NC Dimensions

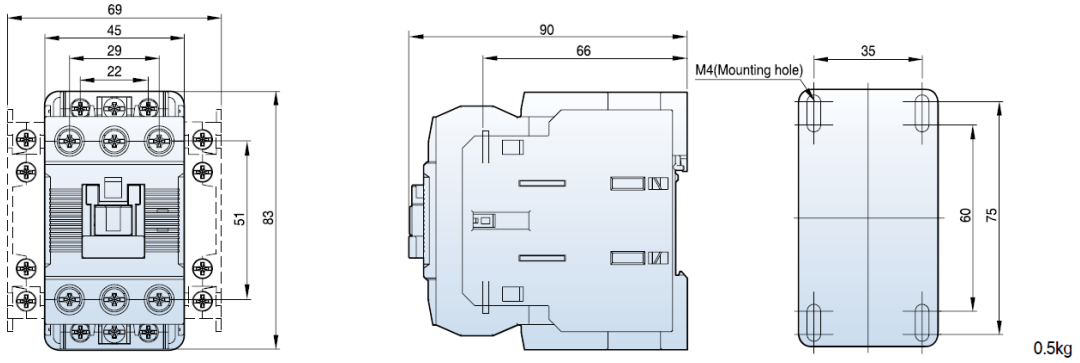

### MC-32A~40A DC 2NO2NC Dimensions

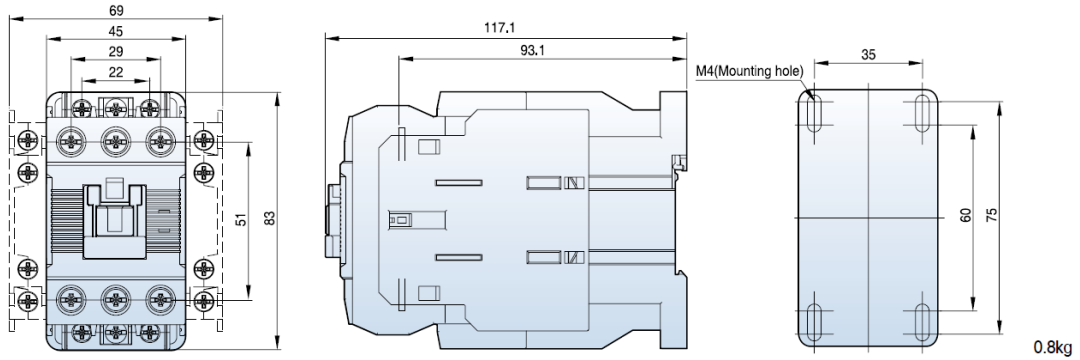

### MC-50A~65A AC Dimensions

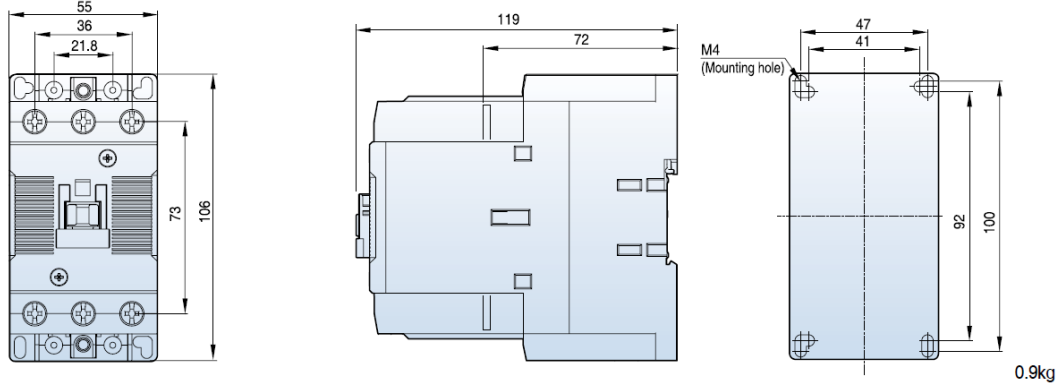

### MC-50A~65A DC Dimensions

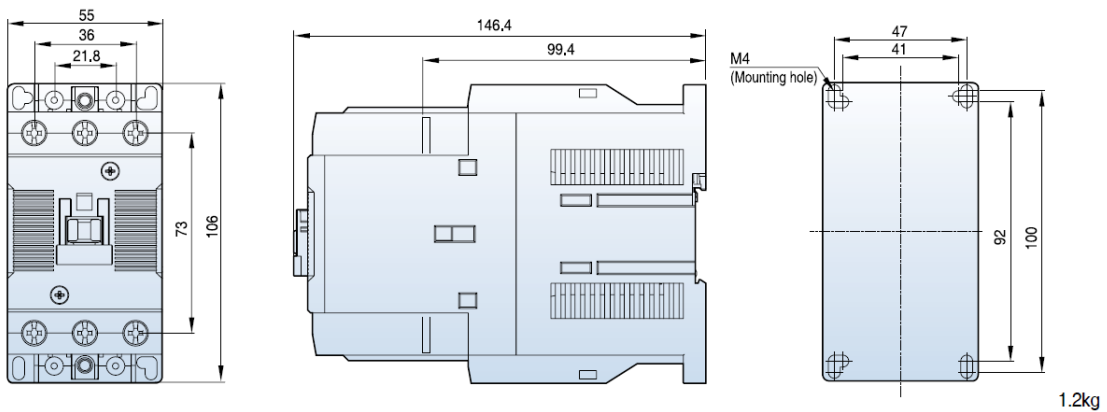

Catalogue number: **MC-□□ □□**



Magnetic Contactors: 3 Pole 6A ~ 2100A 50/60Hz

### MC-50A~65A AC 2NO2NC Dimensions

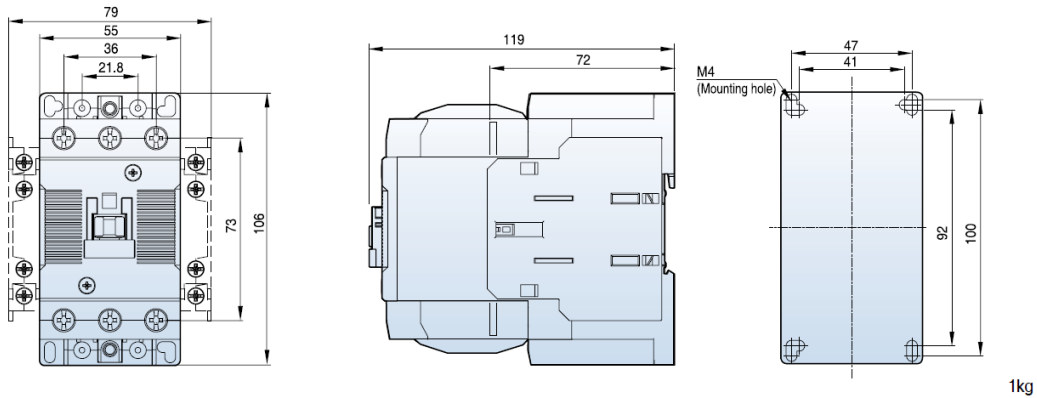

### MC-50A~65A DC 2NO2NC Dimensions

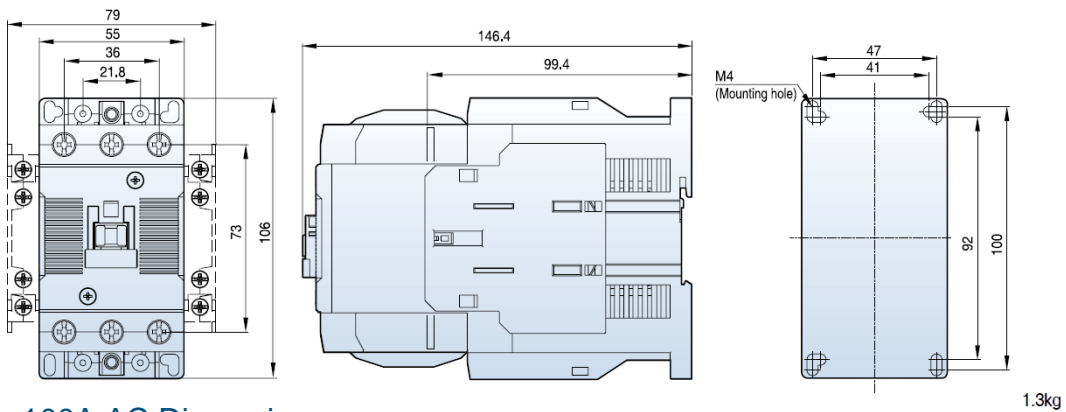

### MC-75A~100A AC Dimensions

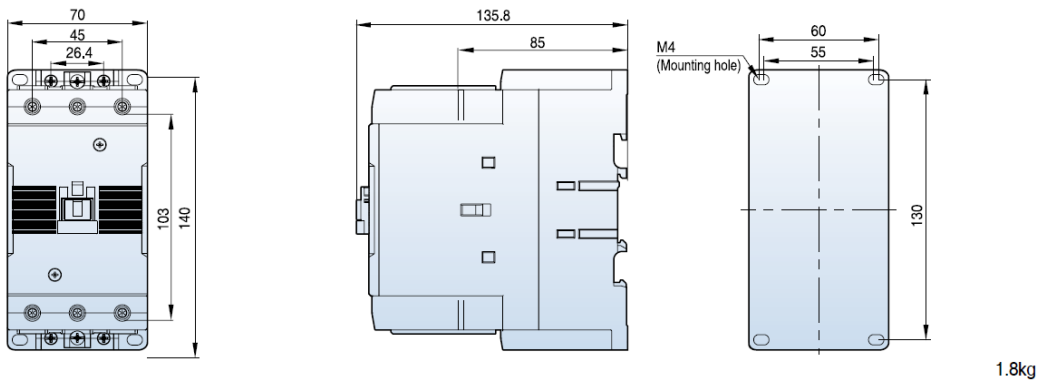

### MC-75A~100A DC Dimensions

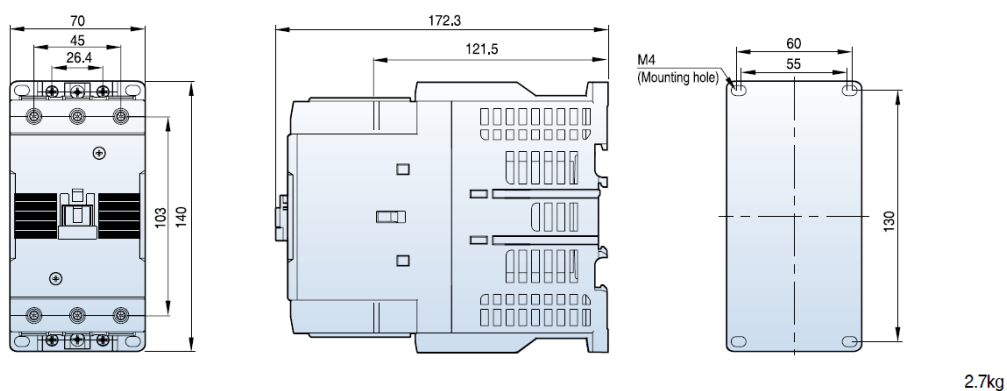

Catalogue number: MC-□□ □□



Magnetic Contactors: 3 Pole 6A ~ 2100A 50/60Hz

### MC-75A~100A AC 2NO2NC Dimensions

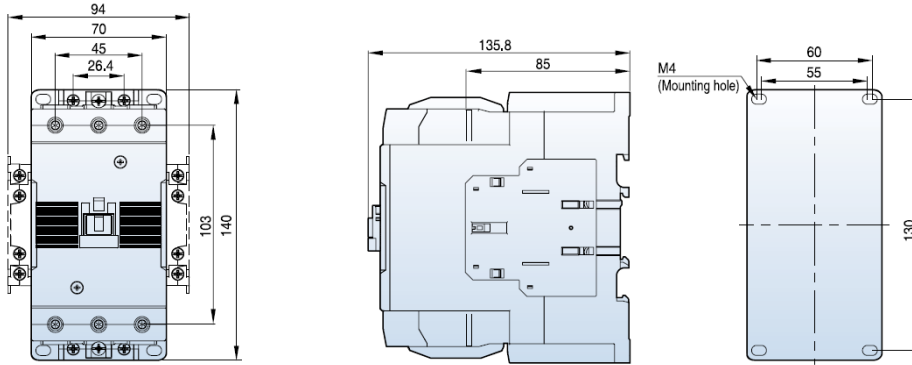

1.9kg

### MC-75A~100A DC 2NO2NC Dimensions

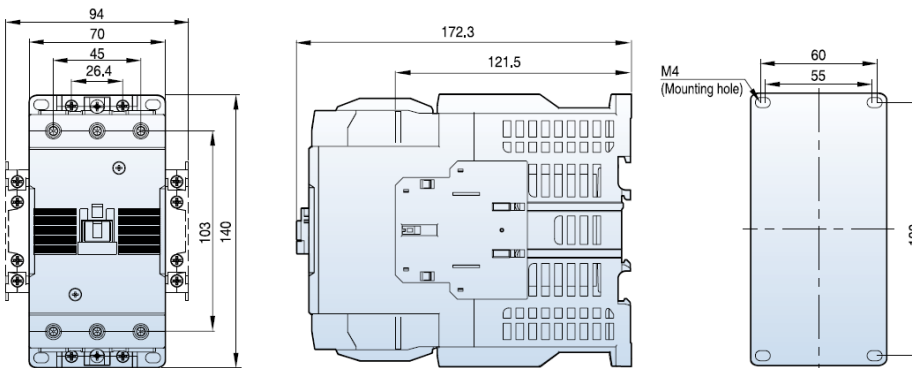

2.8kg

### MC-130A, 150A

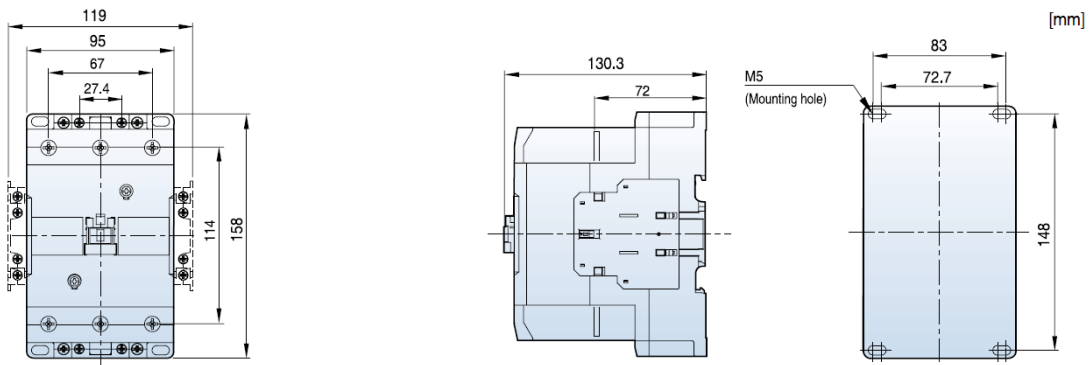

2.4kg

### MC-185A, 225A

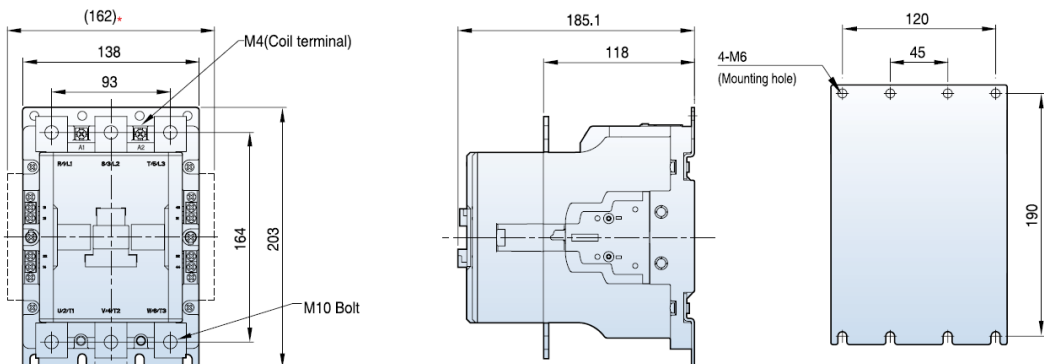

5.4kg



Catalogue number: MC-□□ □□



Magnetic Contactors: 3 Pole 6A ~ 2100A 50/60Hz

### MC-265A, 330A, 400A

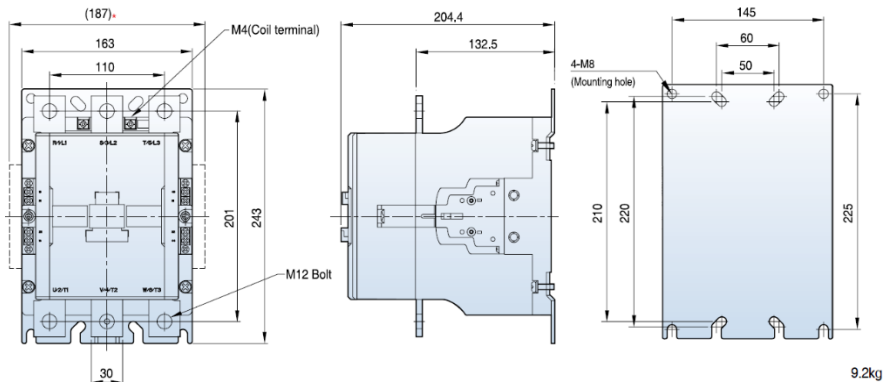

### MC-500A, 630A, 800A

